

SUN Credit Union

12/7/24



Vehicle History Report™

2016 NISSAN MAXIMA

3.5 S

VIN: 1N4AA6AP5GC902349

SEDAN 4 DR

3.5L V6 F DOHC 24V

GASOLINE

FRONT WHEEL DRIVE

Original Window Sticker

Damage reported: minor damage

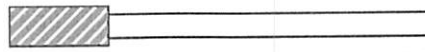

MINOR MODERATE SEVERE



18 Service history records



2 Previous owners



Personal vehicle



202,805 Last reported odometer reading



This CARFAX Vehicle History Report is based only on information supplied to CARFAX and available as of 12/7/24 at 1:23:09 PM (CST). Other information about this vehicle, including problems, may not have been reported to CARFAX. Use this report as one important tool, along with a vehicle inspection and test drive, to make a better decision about your next used car.



Accident / Damage History

Not all accidents / issues are reported to CARFAX

Event 1

03/11/2022

Damage reported: minor damage

Damage Severity Scale

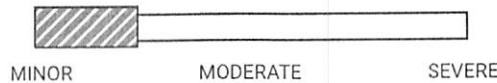

MINOR MODERATE SEVERE

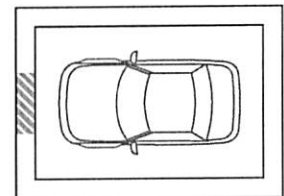

Additional History

Not all accidents / issues are reported to CARFAX

Total Loss

No total loss reported to CARFAX.

Owner 1

No Issues Reported

Owner 2

No Issues Reported

Structural Damage



CARFAX recommends that you have this vehicle inspected by a collision repair specialist.

No Issues Reported

No Issues

[^ Back To Top](#)

Airbag Deployment No airbag deployment reported to CARFAX.	<input checked="" type="checkbox"/> No Issues Reported	<input checked="" type="checkbox"/> No Issues Reported
Odometer Check No indication of an odometer rollback.	<input checked="" type="checkbox"/> No Issues Indicated	<input checked="" type="checkbox"/> No Issues Indicated
Accident / Damage Damage reported: 03/11/2022.	<input checked="" type="checkbox"/> No Issues Reported	Minor Damage
Manufacturer Recall No open recalls reported to CARFAX.	<input checked="" type="checkbox"/> No Recalls Reported	<input checked="" type="checkbox"/> No Recalls Reported
Basic Warranty Original warranty estimated to have expired.	Warranty Expired	Warranty Expired

 Title History CARFAX guarantees the information in this section	Owner 1	Owner 2
Damage Brands Salvage Junk Rebuilt Fire Flood Hail Lemon	<input checked="" type="checkbox"/> Guaranteed No Problem	<input checked="" type="checkbox"/> Guaranteed No Problem
Odometer Brands Not Actual Mileage Exceeds Mechanical Limits	<input checked="" type="checkbox"/> Guaranteed No Problem	<input checked="" type="checkbox"/> Guaranteed No Problem
 GUARANTEED - None of these title problems were reported by a U.S. state Department of Motor Vehicles (DMV). If you find that any of these title problems were reported by a DMV and not included in this report, you may qualify. View Terms View Certificate		

 Ownership History The number of owners is estimated	Owner 1	Owner 2
Year purchased	2016	2019
Type of owner	Personal	Personal
Estimated length of ownership	2 yrs. 9 mo.	5 yrs. 3 mo.
Owned in the following states/provinces	Delaware	Florida
Estimated miles driven per year	9,288/yr	34,644/yr
Last reported odometer reading	27,020	202,805

Detailed History



Owner 1





Purchased: 2016

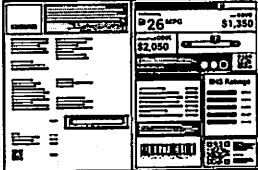

Low mileage! This owner drove less than the industry average of 15,000 miles per year.

Personal Vehicle
9,288 mi/yr

[^ Back To Top](#)

Date	Mileage	Source	Comments
04/19/2016		Nissan North America, Inc.	Vehicle manufactured and shipped to original dealer
			
05/15/2016	13	New York Inspection Station	Passed safety inspection - Emissions inspection performed
06/03/2016		Delaware Motor Vehicle Dept. Camden Wyoming, DE	Title or registration issued - First owner reported - Titled or registered as personal vehicle
06/23/2016		Service Facility	 Vehicle reconditioned
03/20/2017	12,813	Rockaway Nissan Inwood, NY 516-239-0100 4.5 / 5.0 273 Verified Reviews	 Vehicle serviced - Maintenance inspection completed - Oil and filter changed - Tire condition and pressure checked
08/23/2017	17,600	Delaware Motor Vehicle Dept. Camden Wyoming, DE	Registration issued or renewed
05/02/2018	22,356	Rockaway Nissan Inwood, NY 516-239-0100 4.5 / 5.0 273 Verified Reviews	 Vehicle serviced - Maintenance inspection completed - Oil and filter changed - Tire condition and pressure checked
03/30/2019	26,211	Dealer Inventory	Vehicle offered for sale
04/03/2019		Pristine Off-Lease Smyrna, DE 302-653-1244 4.9 / 5.0 33 Verified Reviews ♥ 4 Customer Favorites	 Vehicle serviced - Brakes replaced - Rear brake pads replaced - Front brake pads replaced - Front brake rotor(s) replaced - Four tires balanced - Four tires mounted - Air filter replaced - Oil and filter changed - Brake pads replaced - Rear brake rotor(s) replaced - Wheel lug nuts torqued - Cabin air filter replaced,

04/29/2019 26,679 Auto Auction

Listed as a dealer vehicle
- Vehicle sold



Millions of used vehicles are bought and sold at auction every year.

05/25/2019 26,688 Dealer Inventory

Vehicle offered for sale

07/09/2019 26,692 Georgia Inspection Station

Passed emissions inspection

07/27/2019 27,020 Dealer Inventory

Vehicle offered for sale

 **Owner 2**
Purchased: 2019

Personal Vehicle
34,644 mi/yr

Date **Mileage** **Source** **Comments**

08/11/2019 27,021 Florida Motor Vehicle Dept.

Vehicle purchase reported

08/29/2019 Florida Motor Vehicle Dept. Fort Lauderdale, FL

Title issued or updated
- Registration issued or renewed
- New owner reported
- Titled or registered as personal vehicle
- Loan or lien reported
- Vehicle color noted as Brown

09/30/2019 33,376 Lorenzo Nissan Ft. Lauderdale Fort Lauderdale, FL 954-527-3400

 **Vehicle serviced**
- Tires rotated
- Alignment checked

★ 4.4 / 5.0
366 Verified Reviews
♥ 4,000 Customer Favorites

11/05/2019 40,542 Lorenzo Nissan Ft. Lauderdale Fort Lauderdale, FL 954-527-3400

 **Vehicle serviced**

★ 4.4 / 5.0
366 Verified Reviews
♥ 4,000 Customer Favorites

11/19/2019 Florida Motor Vehicle Dept. Fort Lauderdale, FL

Title issued or updated
- Titled or registered as personal vehicle
- Vehicle color noted as Brown

12/17/2019 47,989 Lorenzo Nissan Ft. Lauderdale

 **Vehicle serviced**
- Maintenance inspection

[^ Back To Top](#)

Fort Lauderdale, FL
954-527-3400

4.4 / 5.0

366 Verified Reviews

 4,000 Customer Favorites

- Oil and filter changed
- Air filter replaced
- Battery/charging system checked
- Brake fluid flushed/changed
- Tires rotated
- Anti-theft/keyless remote battery replaced
- Vehicle washed/detailed
- Cabin air filter replaced/cleaned

05/21/2020 67,357

Lorenzo Nissan Ft. Lauderdale
Fort Lauderdale, FL
954-527-3400

4.4 / 5.0

366 Verified Reviews

 4,000 Customer Favorites



Vehicle serviced

- Tires rotated
- Vehicle washed/detailed

07/20/2020

Florida
Motor Vehicle Dept.
Port Saint Lucie, FL

Registration issued or renewed

- Titled or registered as personal vehicle
- Loan or lien reported
- Registration updated when owner moved the vehicle to a new location
- Vehicle color noted as Brown

08/13/2020 78,241

Lorenzo Nissan Ft. Lauderdale
Fort Lauderdale, FL
954-527-3400

4.4 / 5.0

366 Verified Reviews

 4,000 Customer Favorites



Vehicle serviced

- Brakes checked
- Oil and filter changed

11/18/2020 89,965

Walmart Auto Care Center
Port Saint Lucie, FL
772-335-9242

4.2 / 5.0

82 Verified Reviews

 2 Customer Favorites



Vehicle serviced

- Oil and filter changed

01/27/2021 97,321

Oil Exchange - US1
Port Saint Lucie, FL
772-335-4484

4.7 / 5.0

112 Verified Reviews

 89 Customer Favorites



Vehicle serviced

- Air filter replaced
- Oil and filter changed

03/23/2021 105,152

Oil Exchange - US1
Port Saint Lucie, FL
772-335-4484



Vehicle serviced

- Oil and filter changed

[^ Back To Top](#)

★ 4.7 / 5.0

112 Verified Reviews

♥ 89 Customer Favorites

07/06/2021 119,571

Oil Exchange - US1
Port Saint Lucie, FL
772-335-4484



Vehicle serviced

- Tires rotated
- Oil and filter changed

★ 4.7 / 5.0

112 Verified Reviews

♥ 89 Customer Favorites

11/27/2021 140,806

Oil Exchange - US1
Port Saint Lucie, FL
772-335-4484



Vehicle serviced

- Oil and filter changed
- Cabin air filter replaced/cleaned

★ 4.7 / 5.0

112 Verified Reviews

♥ 89 Customer Favorites

03/11/2022

Damage Report



Damage reported: minor damage

- Damage to front

Damage Severity Scale

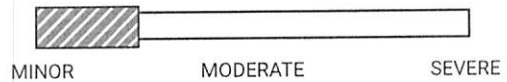

Damage Location

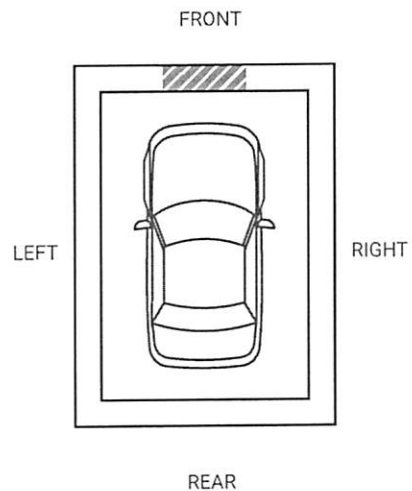

Minor damage is usually cosmetic, including dents or scratches to the vehicle body.

03/24/2022 156,709

Dyer Chevrolet Fort
Pierce



Vehicle serviced

- A/C refrigerant recharge

^ Back To Top

Fort Pierce, FL
772-461-4800

4.3 / 5.0

269 Verified Reviews

 4,584 Customer Favorites

08/25/2022

Florida
Motor Vehicle Dept.
Coral Springs, FL

Registration issued or renewed

- Titled or registered as personal vehicle
- Loan or lien reported
- Registration updated when owner moved the vehicle to a new location
- Vehicle color noted as Brown

05/17/2023 185,639

Inn-N-Out
Fort Lauderdale, FL
954-522-5972

5.0 / 5.0

112 Verified Reviews

 102 Customer Favorites



Vehicle serviced

- Oil and filter changed

02/15/2024 197,716

Walmart Auto Care
Center
Fort Lauderdale, FL
954-453-6535

4.2 / 5.0

113 Verified Reviews



Vehicle serviced

- Tire pressure monitoring system checked
- Tire(s) replaced

05/06/2024 200,306

Gainesville Nissan
Gainesville, FL
352-505-8760

4.6 / 5.0

862 Verified Reviews

 9,564 Customer Favorites



Vehicle serviced

- Recommended maintenance performed
- Maintenance inspection completed
- Tires rotated
- Oil and filter changed

09/05/2024 202,805

Florida
Motor Vehicle Dept.
Hollywood, FL

Odometer reading reported

10/02/2024

Florida
Motor Vehicle Dept.
Fort Lauderdale, FL

Registration issued or renewed

- Titled or registered as personal vehicle
- Loan or lien reported
- Registration updated when owner moved the vehicle to a new location
- Vehicle color noted as Brown

10/14/2024

Florida
Motor Vehicle Dept.
Hollywood, FL

Title issued or updated

- Vehicle repossessed
- Vehicle color noted as Brown

Have Questions? Please visit our Help Center at www.carfax.com.

 [Back To Top](#)



Damage Indicator

Damage can be a result of many different types of events. Examples include contact with objects (other cars, trees, traffic signs, road debris, etc), vandalism, or weather-related events. Not every damage event is reported to CARFAX. As details about the damage event become available, those additional details are added to the CARFAX Vehicle History Report. CARFAX recommends that you have this vehicle inspected by a qualified mechanic.

- This CARFAX Vehicle History Report is based only on information supplied to CARFAX and available as of 12/7/24 at 1:23:09 PM (CST). Other information about this vehicle, including problems, may not have been reported to CARFAX. Use this report as one important tool, along with a vehicle inspection and test drive, to make a better decision about your next used car.

Damage Severity

Damage events result in one of the following severity levels:

- Minor: Generally, minor damage is cosmetic (including dents or scratches), may only require reconditioning, and typically does not compromise a vehicle's operation and/or safety.
- Moderate: Moderate damage may affect multiple components of the vehicle and may impair the vehicle's operation and/or safety.
- Severe: Severe damage usually affects multiple components of the vehicle and is likely to compromise the vehicle's operation and/or safety.

CARFAX recommends getting a pre-purchase inspection at a certified collision repair facility.

First Owner

When the first owner(s) obtains a title from a Department of Motor Vehicles as proof of ownership.

New Owner Reported

When a vehicle is sold to a new owner, the Title must be transferred to the new owner(s) at a Department of Motor Vehicles.

Ownership History

CARFAX defines an owner as an individual or business that possesses and uses a vehicle. Not all title transactions represent changes in ownership. To provide estimated number of owners, CARFAX proprietary technology analyzes all the events in a vehicle history. Estimated ownership is available for vehicles manufactured after 1991 and titled solely in the US including Puerto Rico. Dealers sometimes opt to take ownership of a vehicle and are required to in the following states: Maine, Massachusetts, New Jersey, Ohio, Oklahoma, Pennsylvania and South Dakota. Please consider this as you review a vehicle's estimated ownership history.

Repossession

When a repossession occurs a vehicle owner fails to make loan payments, and the financial institution holding the title takes possession of the vehicle.

Title Issued

A state issues a title to provide a vehicle owner with proof of ownership. Each title has a unique number. Each title or registration record on a CARFAX report does not necessarily indicate a change in ownership. In Canada, a registration and bill of sale are used as proof of ownership.

Follow Us:



[facebook.com/CARFAX](https://www.facebook.com/CARFAX)



[@CARFAXinc](https://twitter.com/CARFAXinc)



[About CARFAX](#)

CARFAX DEPENDS ON ITS SOURCES FOR THE ACCURACY AND RELIABILITY OF ITS INFORMATION. THEREFORE, NO RESPONSIBILITY IS ASSUMED BY CARFAX OR ITS AGENTS FOR ERRORS OR OMISSIONS IN THIS REPORT. CARFAX FURTHER EXPRESSLY DISCLAIMS ALL WARRANTIES, EXPRESS OR IMPLIED, INCLUDING ANY IMPLIED WARRANTIES OF MERCHANTABILITY OR FITNESS FOR A PARTICULAR PURPOSE.

© 2024 CARFAX, Inc., part of S&P Global. All rights reserved.
12/7/24 1:23:09 PM (CST)



2016 NISSAN MAXIMA S



Scan QR code for general model information & options

Manufacturer's Suggested Retail Base Price:	\$32,510.00
Options Included by Manufacturer: SPLASH GUARDS FLOOR MATS, TRUNK MAT & TRUNK NET (5-piece set)	190.00 220.00
DESTINATION CHARGES	835.00
Total*	\$33,755.00

Standard Equipment Included at No Extra Charge

- MECHANICAL & PERFORMANCE**
- 3.5-Liter DOHC 24-Valve V6 Engine
- 300 Horsepower & 261 lb-ft Torque
- Xtreme Transmission
- Drive Mode Selector (Normal & Sport)
- 18" Machined Aluminum Alloy Wheels
- SAFETY & SECURITY**
- Driver & Front Passenger Side-impact
- 16 Curtain Air Bag
- Childers & Lethers for Children (LATCH)
- 4-Wheel Anti-Lock Braking System (ABS)
- Vehicle Dynamic Control (VDC)
- W/ Traction Control System (TCS)
- Electronic Brake Force Distribution (EBD)
- & Brake Assist (BA)
- Tire Pressure Monitoring System (TPMS)
- & Easy-Fill Tire Alert
- Nissan Vehicle Immobilizer System
- Vehicle Security System

EXTERIOR

- Halogen Headlights
- Automatic On/Off Headlights
- LED Signature Daytime Running Lights
- Front Fog Lights (Halogen)

COMFORT & CONVENIENCE

- NissanConnect™ W/ Navigation**
- 8.0 Color Display W/ Multi-Touch Control
- Nissan Voice Recognition For Navigation & Audio
- RearView Monitor (RVM)
- Remote Engine Start W/ Intelligent Climate Control
- 8-Way Power Driver's & 4-Way Power Front Passenger's Seat
- Cloth Seats
- "Zero Gravity" Front Seats
- 60/40 Split Fold Down Rear Seats
- "Razor Steel" Faceted Finishers
- Leather-Wrapped "D-Shaped" Steering Wheel
- Cruise Control
- AM/FM/CD Audio System W/ 8 Speakers
- SiriusXM Satellite Radio***
- SiriusXM Traffic & SiriusXM Travel Link****
- Bluetooth® Hands-Free Phone System
- Streaming Audio Via Bluetooth® (AD2D)
- 7-Zone Automatic Temperature Control
- Nissan Intelligent Key® W/ Push Button Ignition
- HomeLink® Universal Receiver
- Two Front USB Connection Ports

**Subscription Agreement required. "Never" program while driving. GPS mapping may not be detailed in all areas or reflect current road status.

***SiriusXM includes activation & 3 Months of service only, subscription sold separately. SiriusXM services are not available in AK, HI and some markets.

****Optional Equipment replaces Standard where applicable

*Does not include dealer installed options and accessories, local taxes or license fees. This label has been applied pursuant to federal law. Do not remove prior to delivery to the ultimate purchaser.

**Not actual Monroney Label. Provided for informational purposes only. Vehicle features, pricing and other information subject to change, may vary from actual vehicle content and/or Monroney label description. While Nissan makes reasonable efforts to ensure accuracy of information, Nissan is not responsible for changes, errors or omissions. See actual vehicle and/or verify information in question with your Nissan dealer.

EPA DOT Fuel Economy and Environment

Fuel Economy
25 MPG
combined city/hwy

22 city
30 highway

4.0 gallons per 100 miles

You spend
\$1,000
more in fuel costs
over 5 years
compared to the
average new vehicle.

MIDSIZE CARS range from 13 to 114 MPG. The best vehicle rates 119 MPG.

Fuel Economy & Greenhouse Gas Rating



This vehicle emits 360 grams CO₂ per mile. The best emits 0 grams per mile (tailpipe only). Producing and distributing fuel also create emissions. Learn more at fuelconomy.gov.



Smartphone OR Code



Actual results will vary for many reasons, including driving conditions and how you drive and maintain your vehicle. The average new vehicle gets 25 MPG and costs \$9,000 to fuel over 5 years. Cost estimates are based on 15,000 miles per year at \$3.20 per gallon. MPG is miles per gasoline gallon equivalent. Vehicle emissions are a significant cause of climate change and smog.

fuelconomy.gov

Calculate personalized estimates and compare vehicles.

GOVERNMENT 5-STAR SAFETY RATINGS

Overall Vehicle Score Not Rated
Based on the combined ratings of frontal, side and rollover. Should ONLY be compared to other vehicles of similar size and weight.

Frontal Crash Driver Not Rated
Passenger Not Rated
Based on the risk of injury in a frontal impact. Should ONLY be compared to other vehicles of similar size and weight.

Side Crash Front seat ★★★★★
Rear seat ★★★★★
Based on the risk of injury in a side impact.

Rollover ★★★★★
Based on the risk of rollover in a single-vehicle crash.

DELIVERY

VEHICLE COLORS:
EXT: FORGED BRONZE
INT: CHARCOAL

FINAL ASSEMBLY POINT:
SMYRNA
TRANSPORT METHOD:
TRUCK

DEALER:
ROCKAWAY NISSAN
600 BURNSIDE AVE
INWOOD NY
11096

Star ratings range from 1 to 5 stars (★★★★★) with 5 being the highest.
Source: National Highway Traffic Safety Administration (NHTSA)
www.safercar.gov or 1-866-327-4236

This Vehicle qualifies for Nissan's
Security+Plus Extended Protection Plan
The only service agreement backed by
Nissan Extended Services North America!
Ask your dealer for details, or call 1-800-NISSAN-1
for more information

VIN: 1N4AA6FP5GC02349
EMS: 50 STATE EMISSIONS
MDL: 16116-602349 CAT-G
OPT: I-H10L92C02066

20160413224659A5S466